

# **BT111 Development Kit**

DATA SHEET

Wednesday, 07 November 2012

Version 1.0



## **Copyright © 2000-2012 Bluegiga Technologies**

All rights reserved.

Bluegiga Technologies assumes no responsibility for any errors which may appear in this manual. Furthermore, Bluegiga Technologies reserves the right to alter the hardware, software, and/or specifications detailed here at any time without notice and does not make any commitment to update the information contained here. Bluegiga's products are not authorized for use as critical components in life support devices or systems.

The WRAP is a registered trademark of Bluegiga Technologies

The *Bluetooth* trademark is owned by the *Bluetooth* SIG Inc., USA and is licensed to Bluegiga Technologies. All other trademarks listed herein are owned by their respective owners.

## VERSION HISTORY

Version	Comment
1.0	Public version

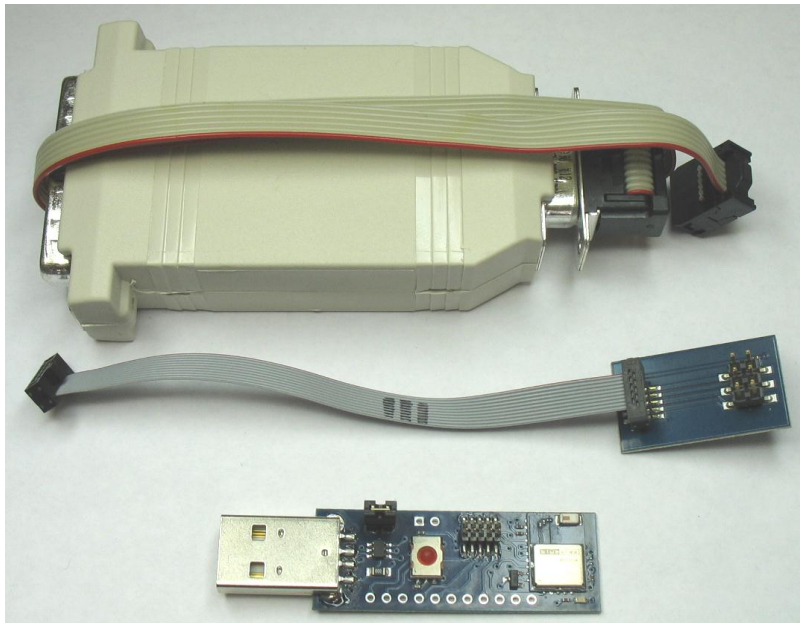
## TABLE OF CONTENTS

1	Design Overview .....	5
2	Using DKBT111 for the First Time .....	7
2.1	Configuring PS keys over SPI.....	8
2.2	Configuring PS keys over USB .....	9
3	Schematic and Layout of DKBT111 .....	11
4	Contact Information .....	14

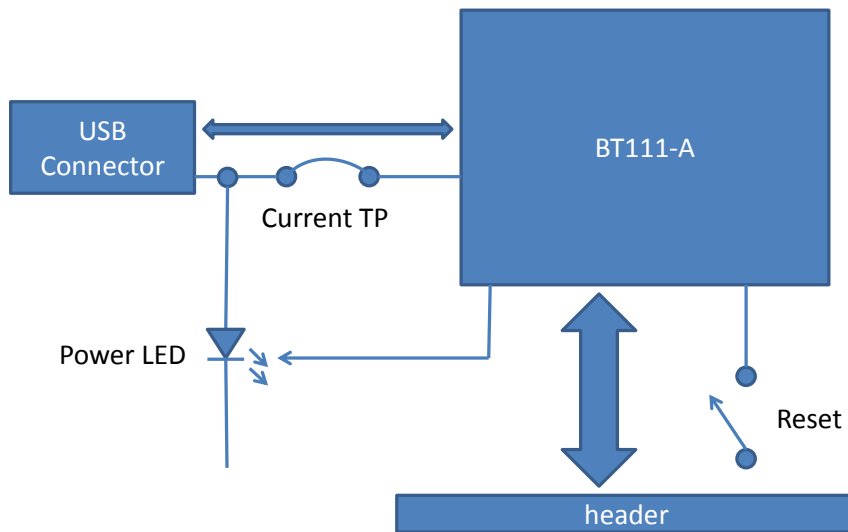
# 1 Design Overview

BT111 development kit is targeted for engineers evaluating BT111 *Bluetooth Smart Ready HCI module* and developing or prototyping *Bluetooth Smart Ready* systems utilizing BT111 module. BT111 Development Kit features:

- BT111 development board including
  - USB connector
  - Header for direct current consumption measurements
  - Reset button
  - Power on LED
  - Header for SPI interface for setting the parameters through SPI
    - All I/Os and supply voltages exposed with 2.54 mm pitch for connecting the kit on prototyping board using a pin header
- Bluegiga on-board installation kit (SPI cable)
- Ribbon cable and an adapter PCB for connecting the SPI with Bluegiga on-board installation kit
- BT111-A sample module

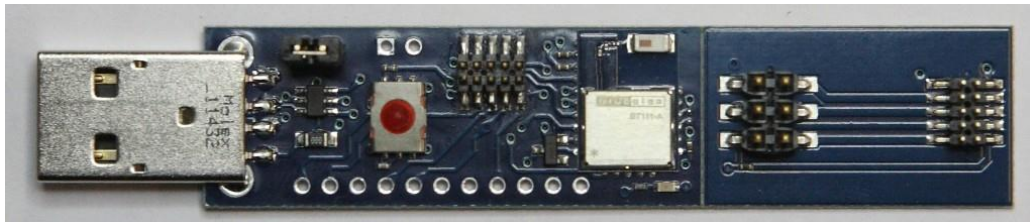


**Figure 1: DKBT111, SPI adapter and programming cable**



**Figure 2: DKBT111 Block Diagram**

Please refer to the latest datasheet of BT111 for information about the BT111 module. The physical outlook of the development board is shown in Figure 3 below.

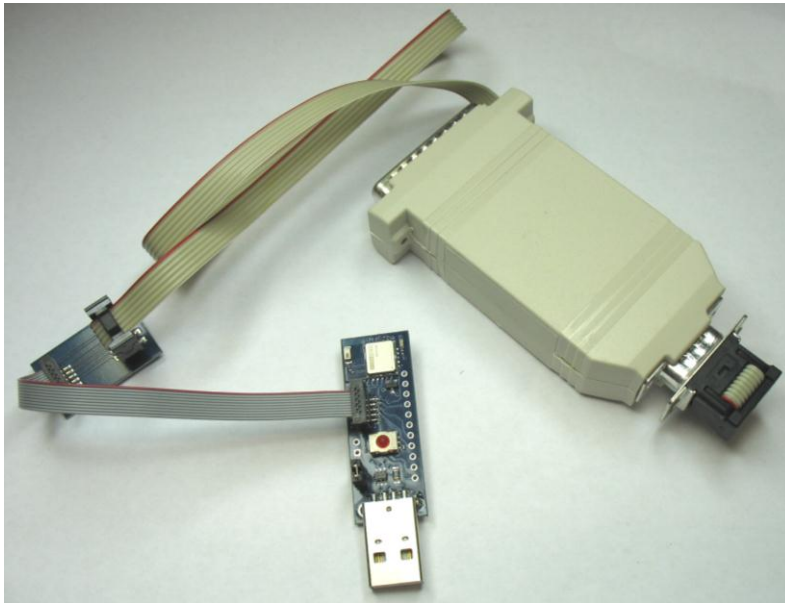


**Figure 3: DKBT111**

## 2 Using DKBT111 for the First Time

As shown in the Figure 3 in previous chapter, the SPI adapter board is attached to the development board. When you start using DKBT111, it is important to first break the adapter off from the development kit. This assures proper operation of the chip antenna. Figure 4 shows the development kit with SPI adapter removed and attached to the on-board installation kit.

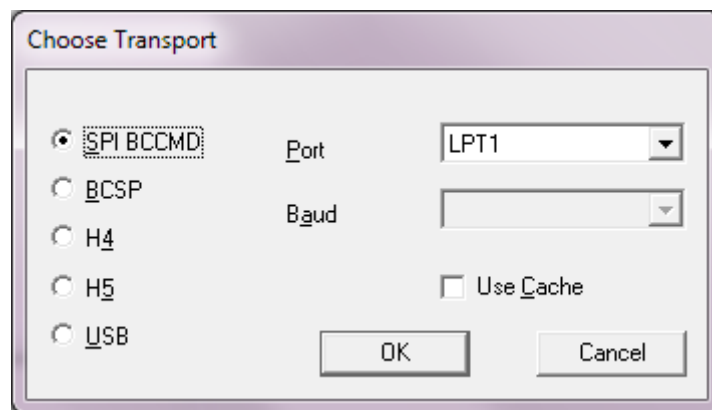
The configuration and test tool suite BlueSuite can be downloaded at the Bluegiga Tech Forum. Please restart your computer after installing BlueSuite like the installer requests. The SPI transport may not work otherwise.



**Figure 4: On-board installation kit connected to DKBT111**

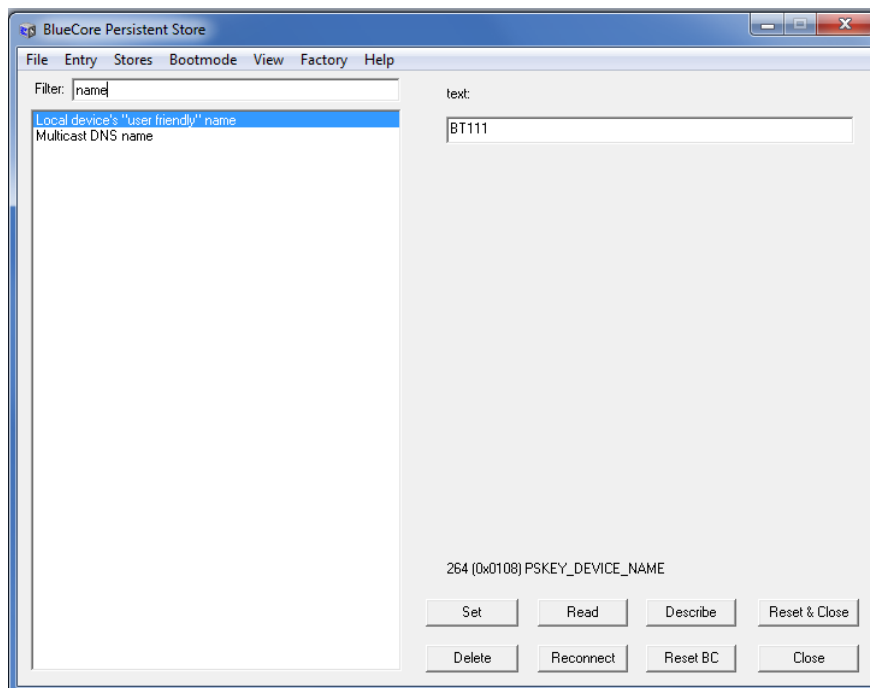
## 2.1 Configuring PS keys over SPI

1. Connect DKBT111 to the USB port of a PC
2. Make sure the power LED turns on
3. Connect the SPI programming cable to the PC and to the SPI interface on the DKBT111
4. Open **PSTool** application and select SPI as the transport as shown in the figure below



**Figure 5: Choosing transport**

You can now modify the PS-keys that are stored on BT111's EEPROM.



**Figure 6: Changing the device friendly name**

**Note:**

**Do not modify the PS-keys unless you are absolutely sure what the change will do or unless you are advised to change a PS-key by Bluegiga.**



## 2.2 Configuring PS keys over USB

Because BT111 is recognized as a generic *Bluetooth* radio by the operating system, the OS will load its own *Bluetooth* stack drivers for the BT111. In order to modify the PS-keys via USB interface a special USB driver needs to be installed.

In order to install the USB driver, please do the following steps:

1. Download the BT111 USB driver from Tech Forum
2. Start **Device Manager** from Windows **Control Panel**
3. Right-click on the **Generic Bluetooth Adapter**, then select **Update Driver Software...**
4. Choose **Browse my computer for driver software**.

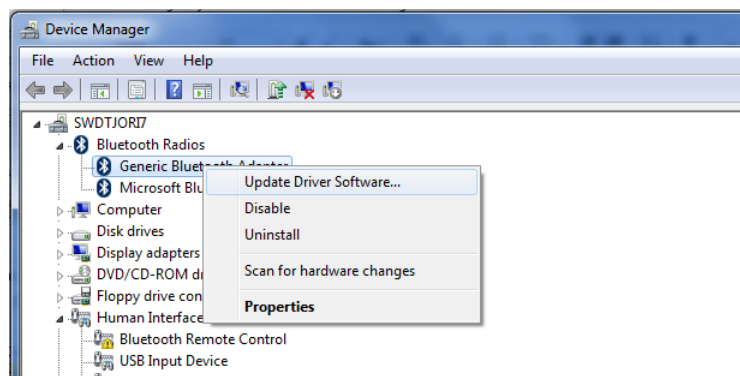


Figure 7: Update driver software

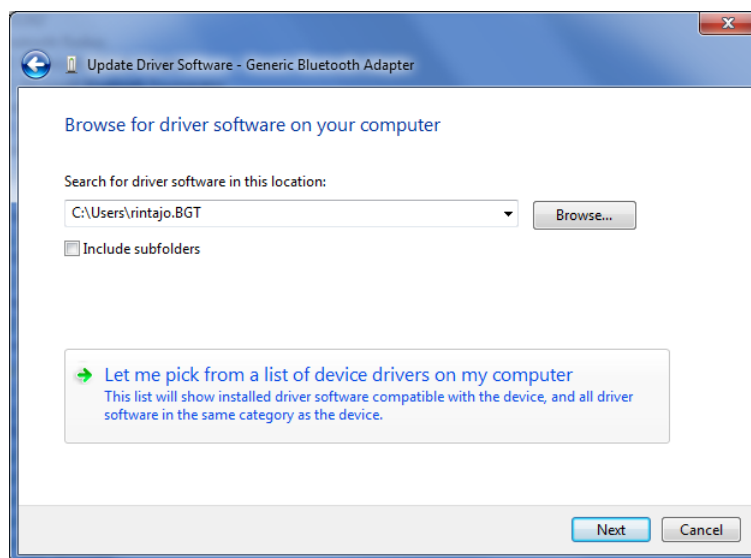
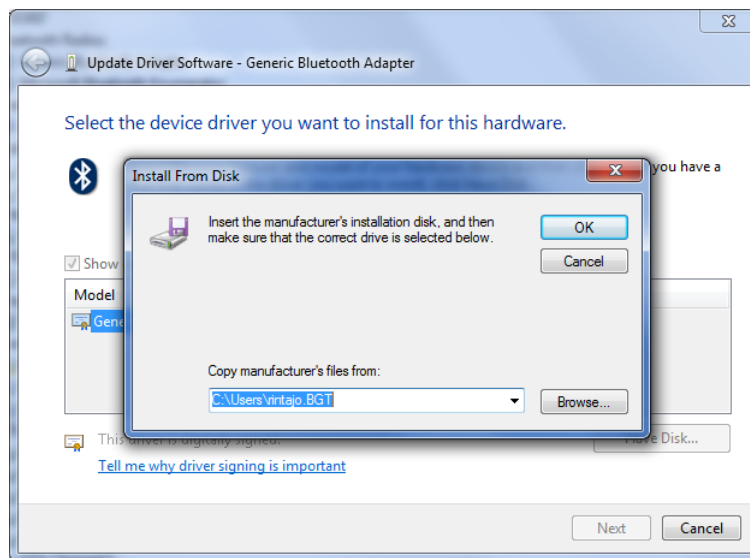


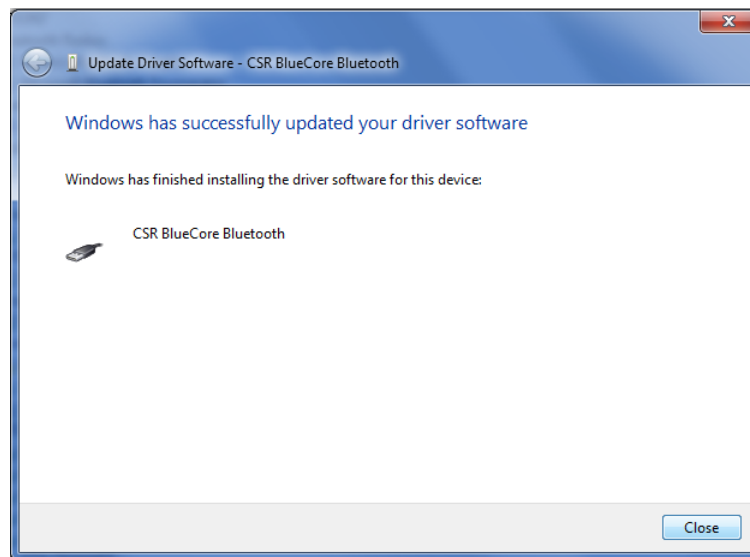
Figure 8. Browse for driver software

1. Click on **Let me pick from a list of device drivers on my computer**, then click **Have Disk...**
2. Select the location where you saved the BT111 USB drivers



**Figure 9: Install from disk**

1. Windows will warn that the driver is not digitally signed; choose to install anyway.



**Figure 10. Installation successful**

When the installation completes, BT111 will re-enumerate as a “**CSR BlueCore Bluetooth**”, and can now be accessed with **PSTool** software. In PSTool Select USB as the transport, the port field will be automatically filled with “\\.\csr0”.

When you wish to return to normal operation, you can repeat the procedure to select a driver from a list, but this time select the Microsoft Generic *Bluetooth* Adapter driver.

### 3 Schematic and Layout of DKBT111

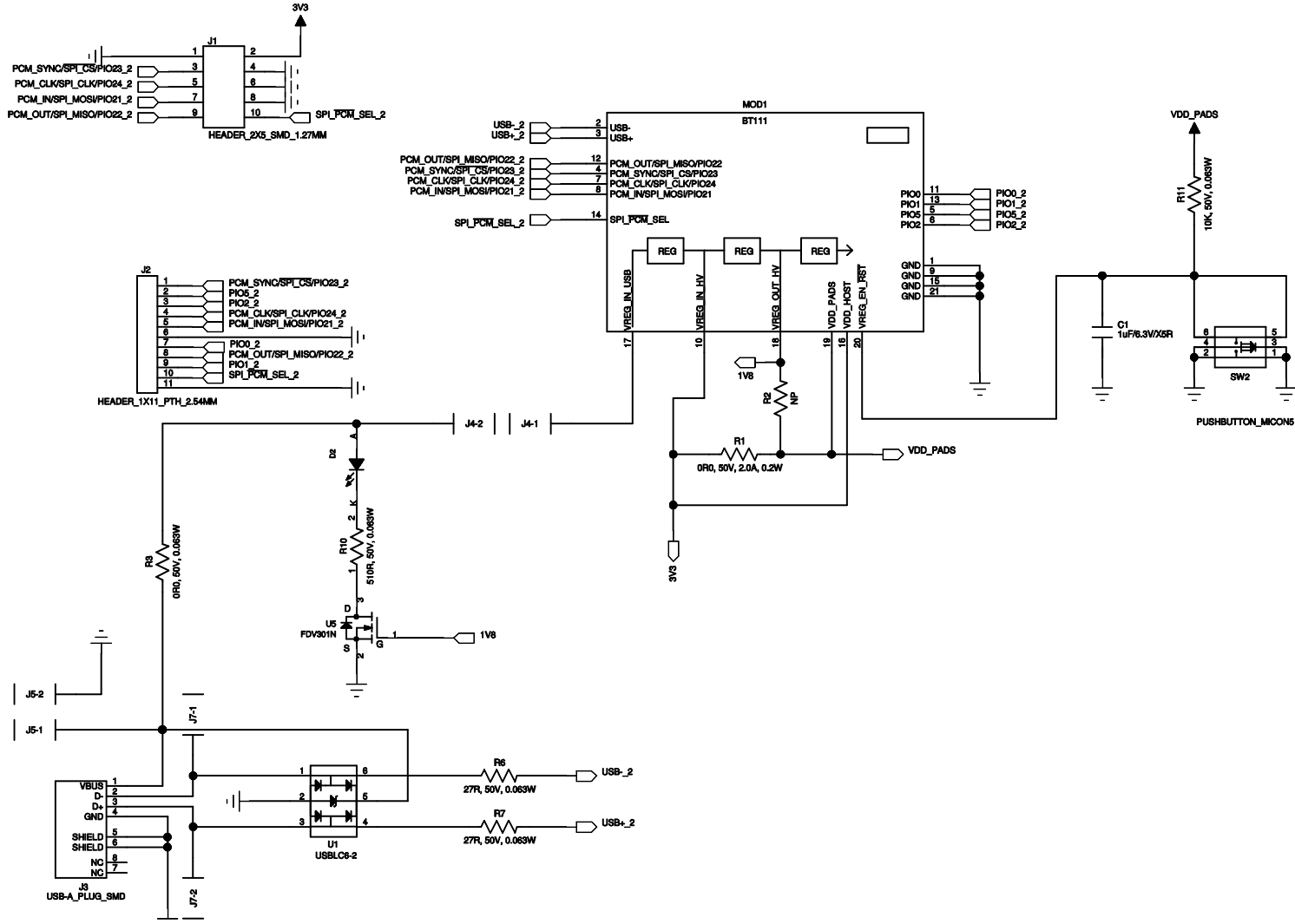


Figure 11: DKBT111 Schematic

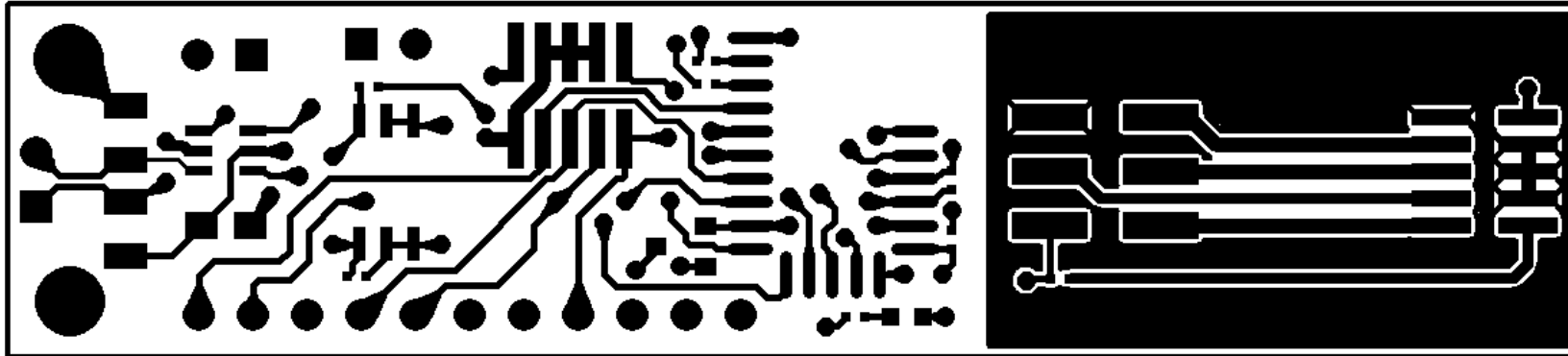


Figure 12: Top layer layout

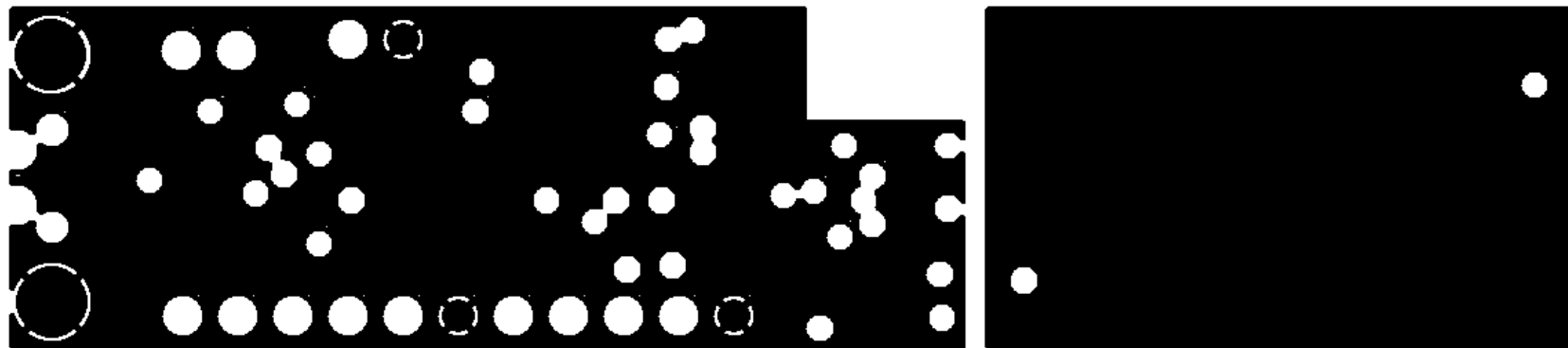


Figure 13: 2nd layer layout

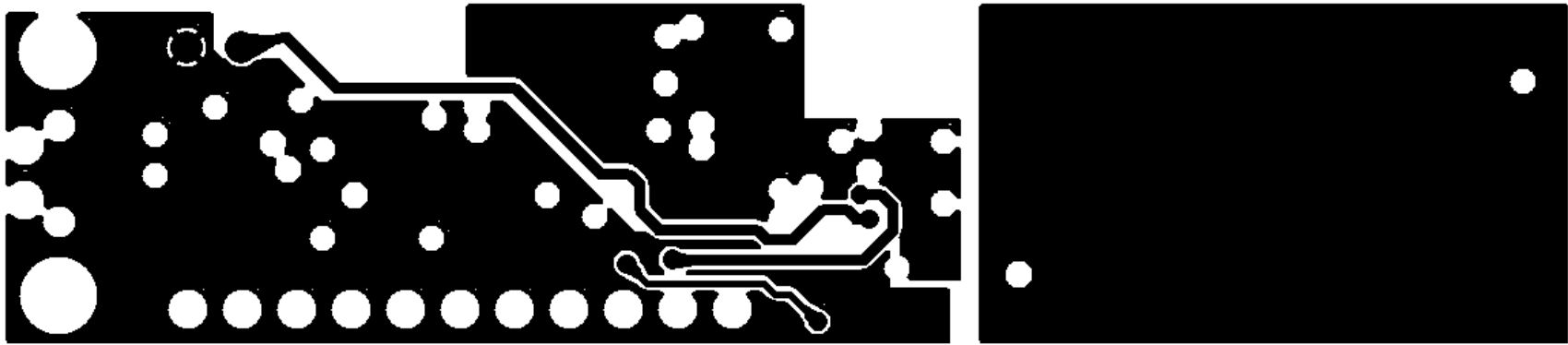


Figure 14: 3rd layer layout

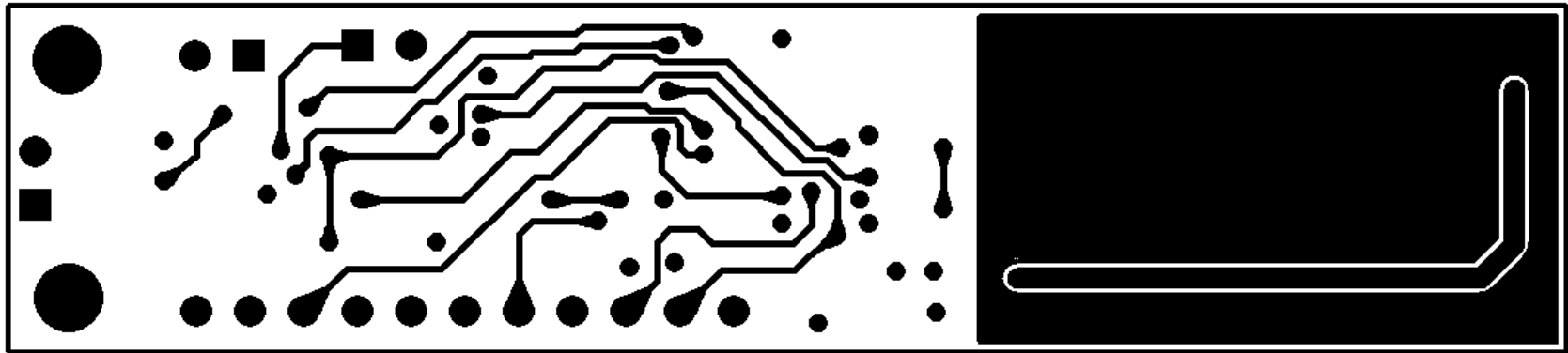


Figure 15: Bottom layer layout

## 4 Contact Information

**Sales:** [sales@bluegiga.com](mailto:sales@bluegiga.com)

**Technical support:** [support@bluegiga.com](mailto:support@bluegiga.com)  
<http://techforum.bluegiga.com>

**Orders:** [orders@bluegiga.com](mailto:orders@bluegiga.com)

**WWW:** [www.bluegiga.com](http://www.bluegiga.com)  
[www.bluegiga.hk](http://www.bluegiga.hk)

**Head Office / Finland:**

Phone: +358-9-4355 060  
Fax: +358-9-4355 0660  
Sinikalliontie 5A  
02630 ESPOO  
FINLAND

**Postal address / Finland:**

P.O. BOX 120  
02631 ESPOO  
FINLAND

**Sales Office / USA:**

Phone: +1 770 291 2181  
Fax: +1 770 291 2183  
Bluegiga Technologies, Inc.  
3235 Satellite Boulevard, Building 400, Suite 300  
Duluth, GA, 30096, USA

**Sales Office / Hong-Kong:**

Phone: +852 3182 7321  
Fax: +852 3972 5777  
Bluegiga Technologies, Inc.  
19/F Silver Fortune Plaza, 1 Wellington Street,  
Central Hong Kong

# Mouser Electronics

Authorized Distributor

Click to View Pricing, Inventory, Delivery & Lifecycle Information:

[Bluegiga Technologies:](#)

[DKBT111](#)